

 SPACE DYNAMICS LABORATORY UTAH STATE UNIVERSITY RESEARCH FOUNDATION North Logan, Utah 84341			
TITLE USUSAT/ION-F CPU Flight Board Top Connector Interface			
SCHEMATIC NAME		INSTANCE NAME	DRAWING NUMBER
top_interface.sbk			30-0075
SCHEMATIC		INSTANCE	SCH-INST SHEET
1 OF 6		1 OF 1	1 OF 1

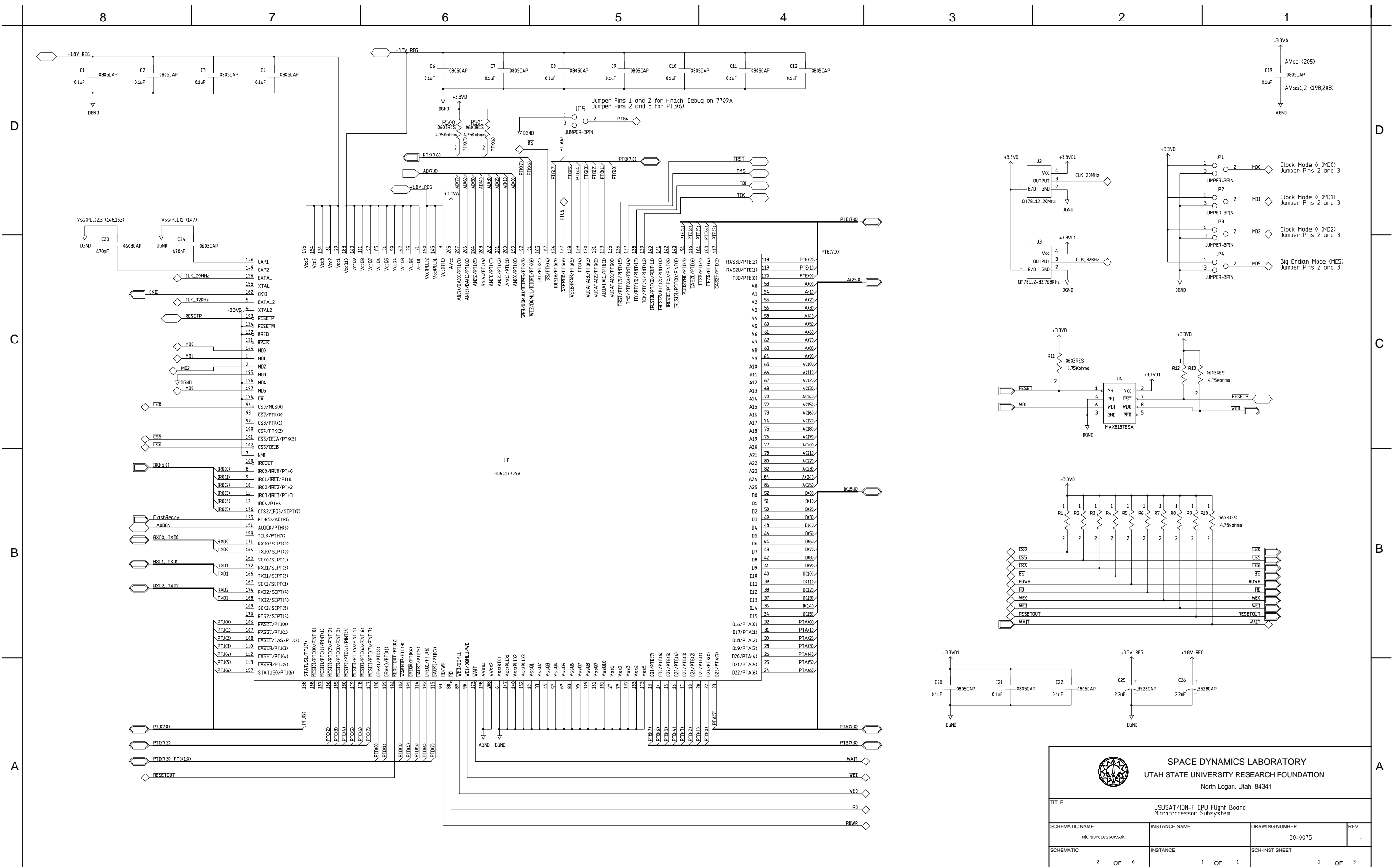



SPACE DYNAMICS LABORATORY
 UTAH STATE UNIVERSITY RESEARCH FOUNDATION
 North Logan, Utah 84341

TITLE USUSAT/ION-F CPU Flight Board Microprocessor Subsystem			
SCHEMATIC NAME microprocessor.sbk	INSTANCE NAME	DRAWING NUMBER 30-0075	REV -
SCHEMATIC 2 OF 6	INSTANCE 1 OF 1	SCH-INST SHEET 1 OF 3	

4

3

2

1

D

D

C

C

B

B

A

A

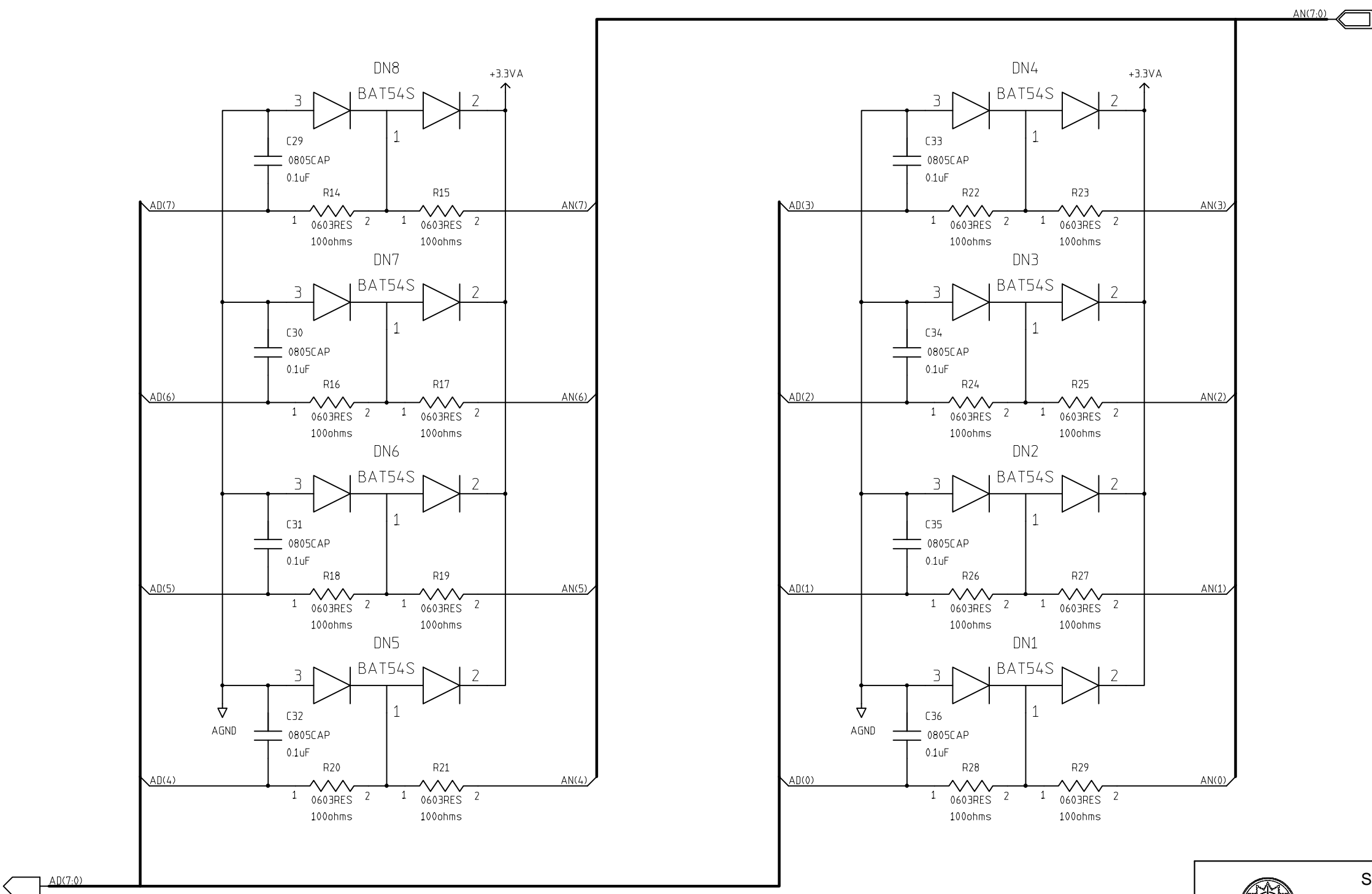

 SPACE DYNAMICS LABORATORY UTAH STATE UNIVERSITY RESEARCH FOUNDATION North Logan, Utah 84341			
TITLE USUSAT/ION-F CPU Flight Board Microprocessor A/D Input Protection			
SCHEMATIC NAME	INSTANCE NAME	DRAWING NUMBER	REV
microprocessor.sbk		30-0075	-
SCHEMATIC	INSTANCE	SCH-INST SHEET	
2	OF 6	1	OF 1
		2	OF 3

4

3

2

1

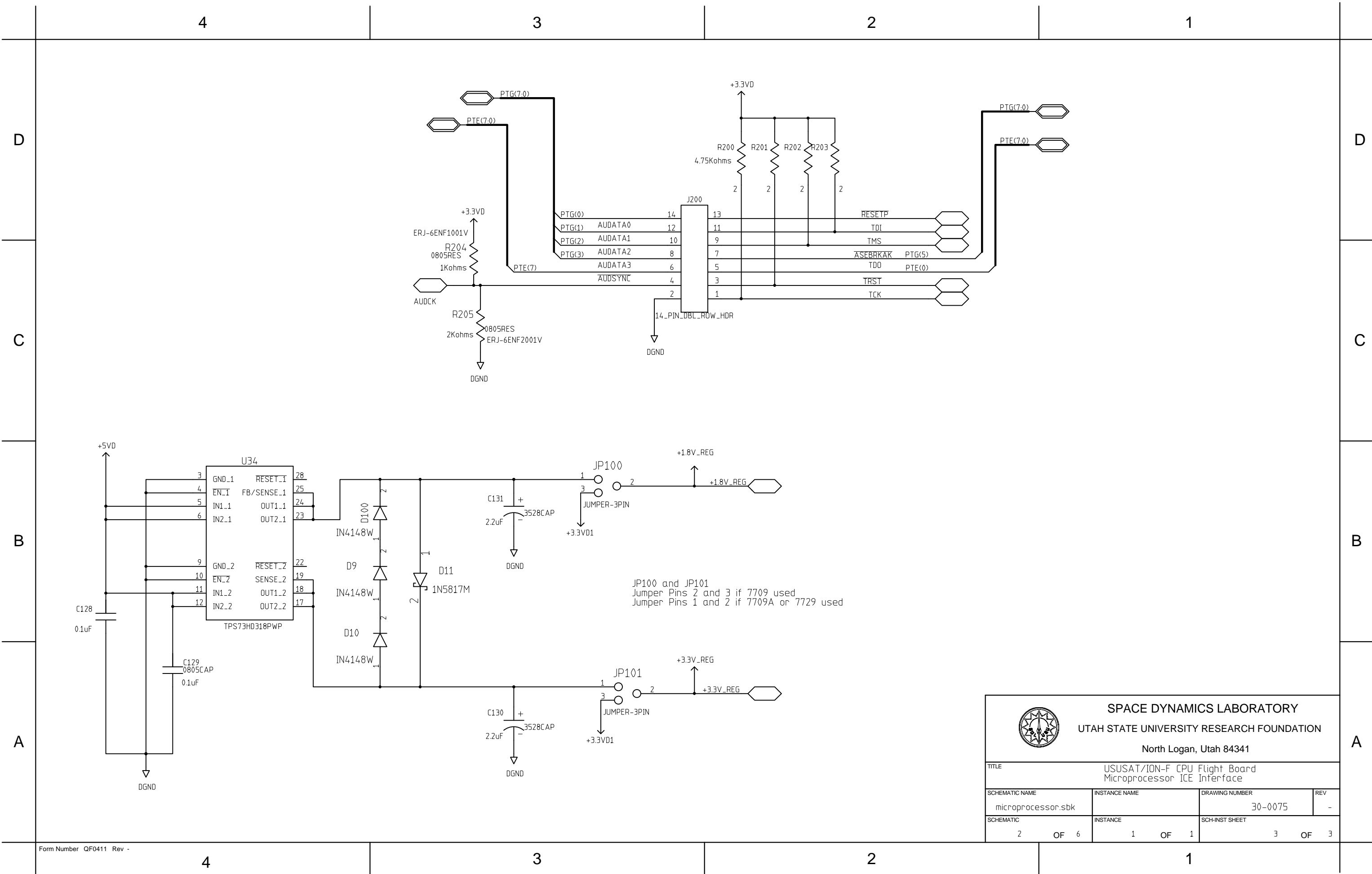

SPACE DYNAMICS LABORATORY
 UTAH STATE UNIVERSITY RESEARCH FOUNDATION
 North Logan, Utah 84341

TITLE			
USUSAT/ION-F CPU Flight Board Microprocessor ICE Interface			
SCHEMATIC NAME	INSTANCE NAME	DRAWING NUMBER	REV
microprocessor.sbk		30-0075	-
SCHEMATIC	INSTANCE	SCH-INST SHEET	
2 OF 6	1 OF 1	3 OF 3	

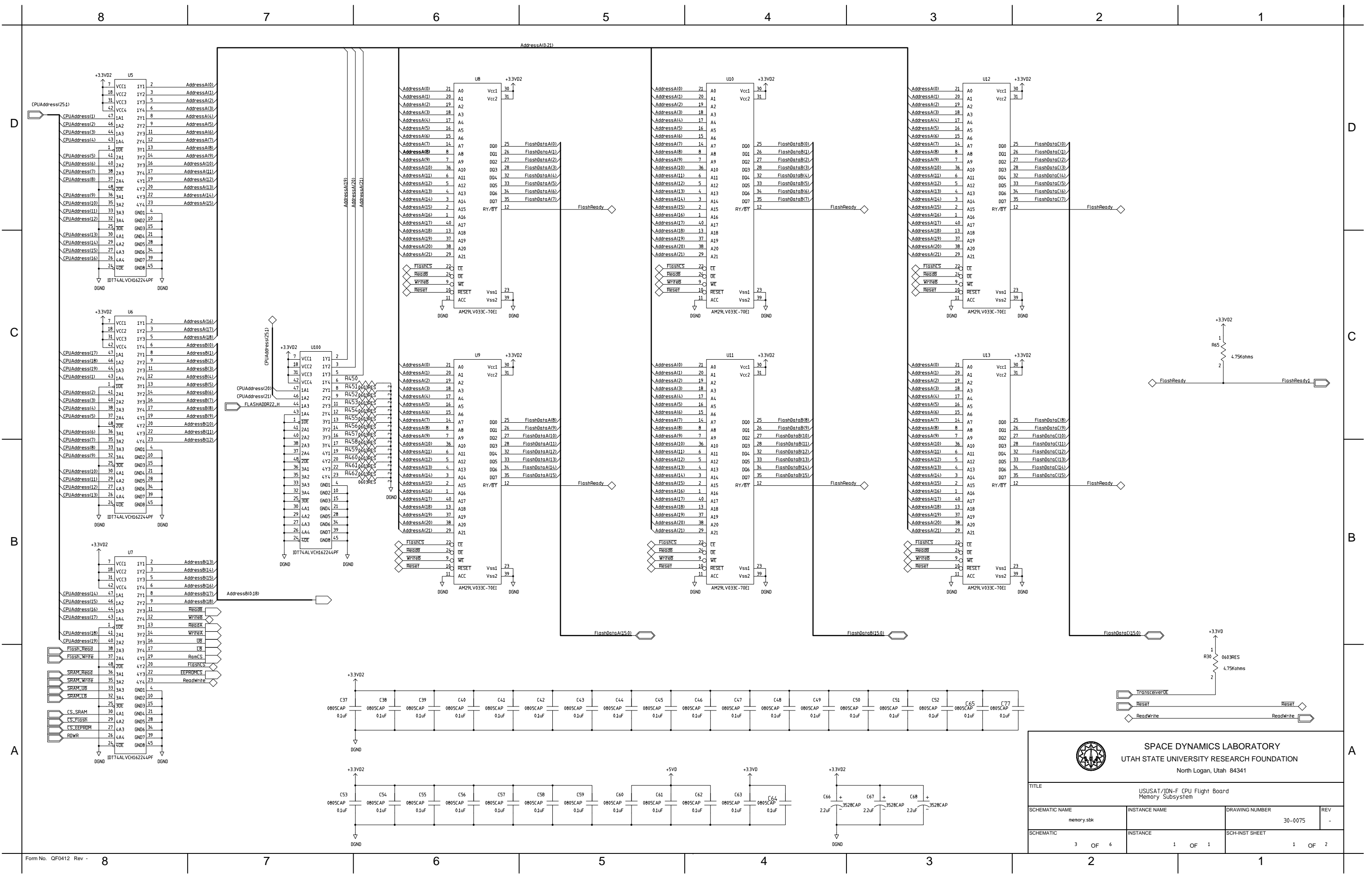



SPACE DYNAMICS LABORATORY
 UTAH STATE UNIVERSITY RESEARCH FOUNDATION
 North Logan, Utah 84341

TITLE USUSAT/JON-F CPU Flight Board Memory Subsystem			
SCHMATIC NAME memory.sbk	INSTANCE NAME	DRAWING NUMBER 30-0075	REV -
SCHMATIC 3 OF 6	INSTANCE 1 OF 1	SCH-INST SHEET 1 OF 2	

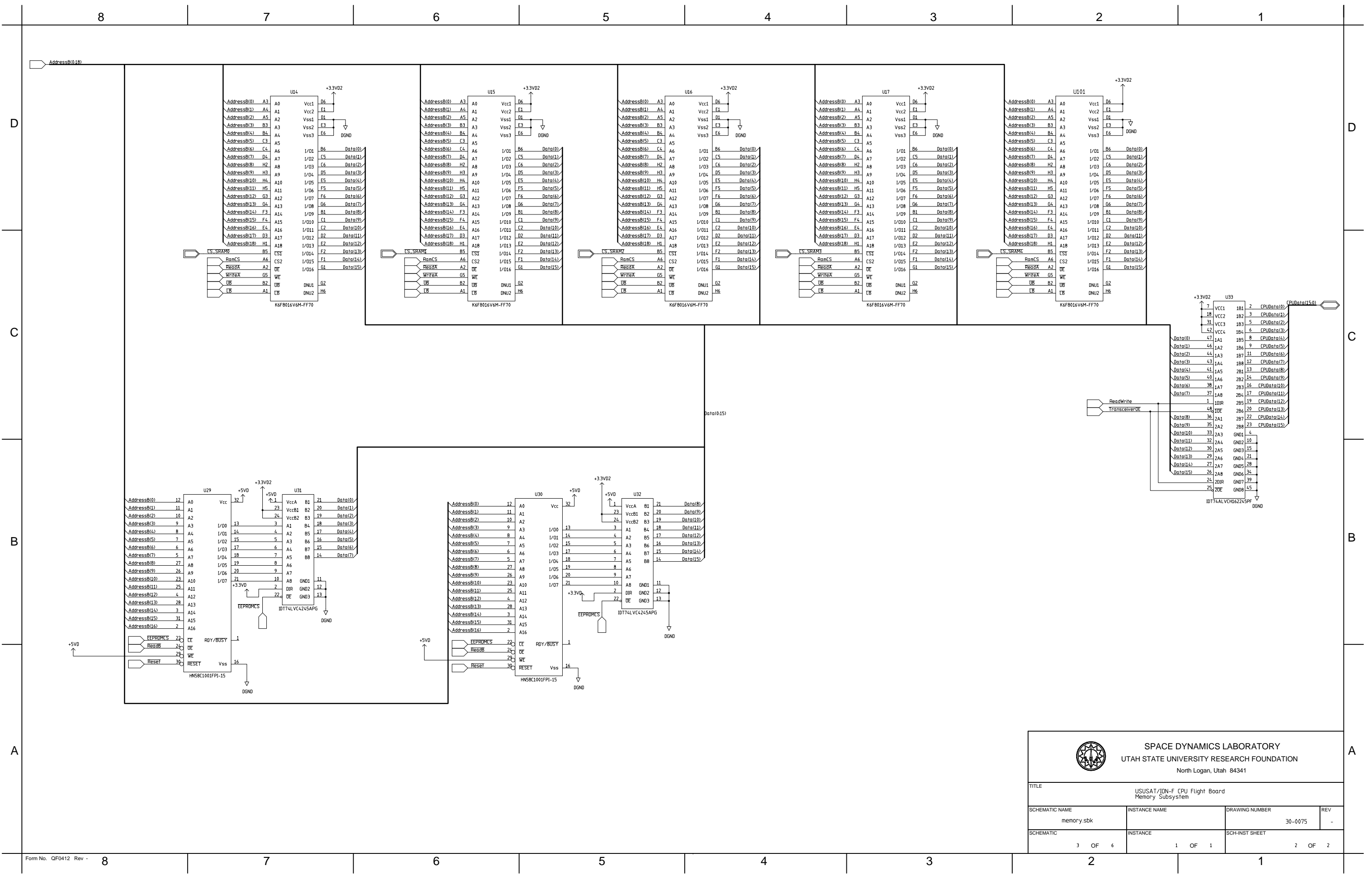

SPACE DYNAMICS LABORATORY
 UTAH STATE UNIVERSITY RESEARCH FOUNDATION
 North Logan, Utah 84341

TITLE			
USUSAT/ION-F CPU Flight Board Memory Subsystem			
SCHMATIC NAME	INSTANCE NAME	DRAWING NUMBER	REV
memory-sbk		30-0075	-
SCHMATIC	INSTANCE	SCH-INST SHEET	
3 OF 6	1 OF 1	2 OF 2	

D

D

C

C

B

B

A

A

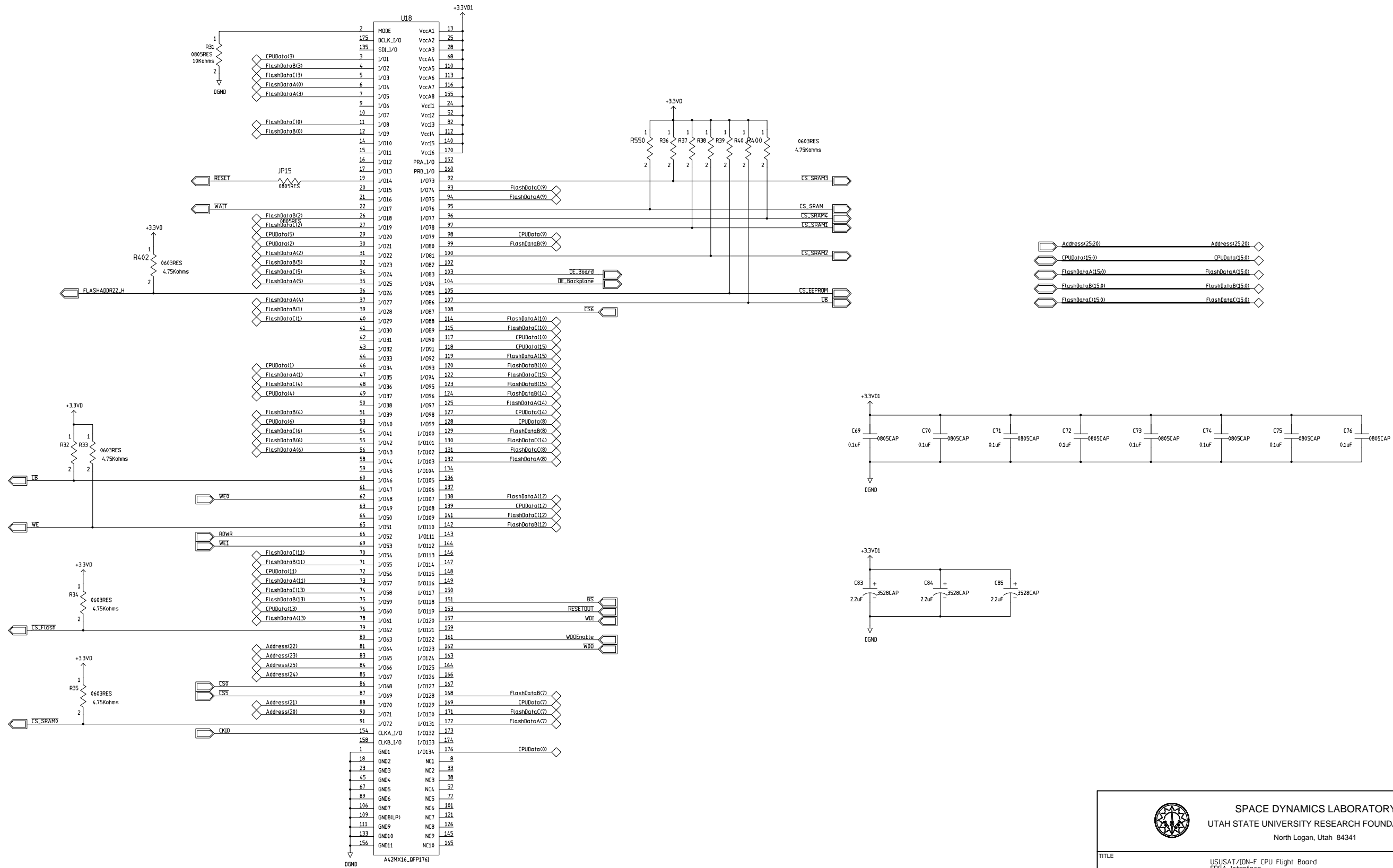

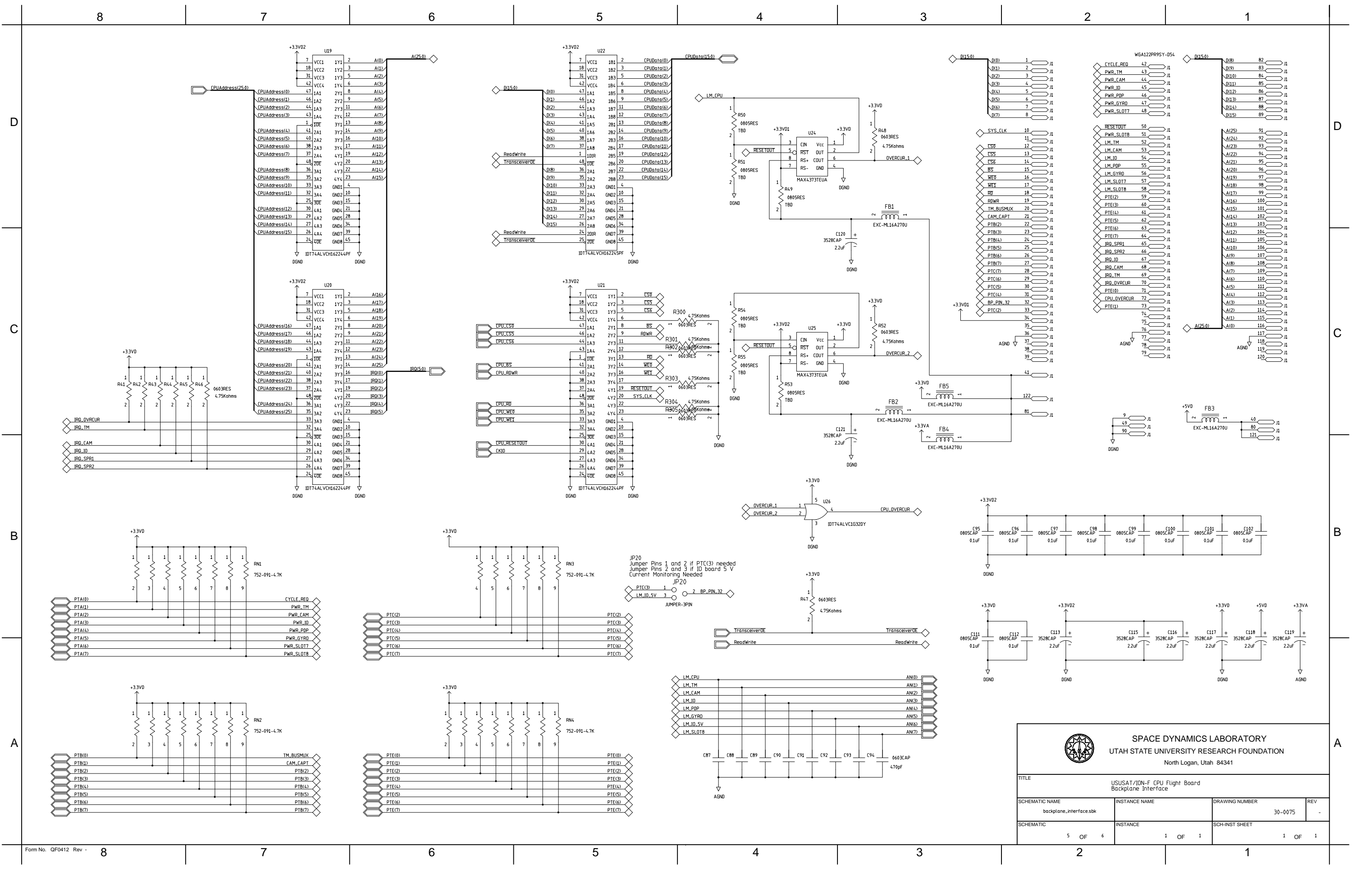

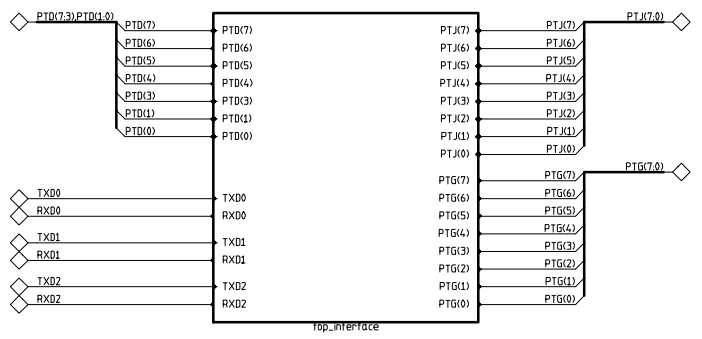
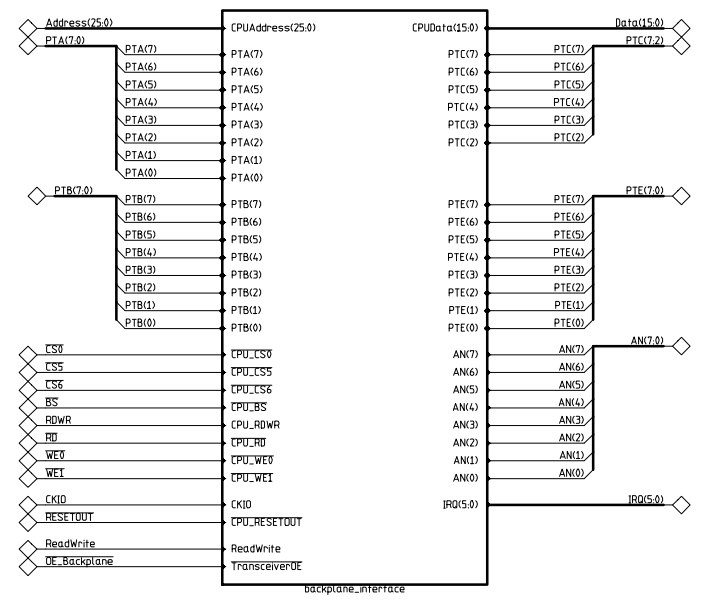
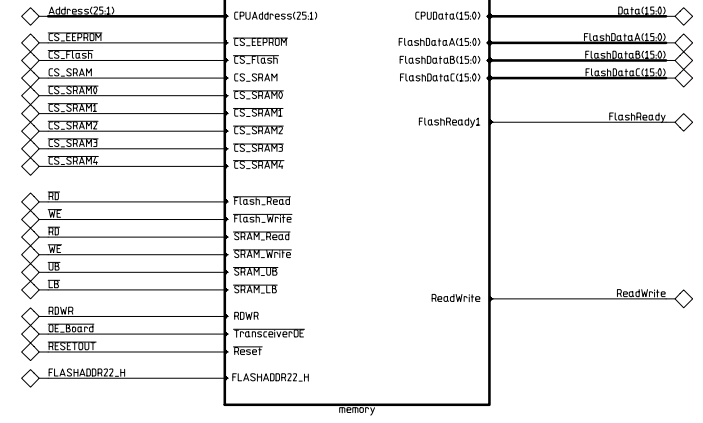
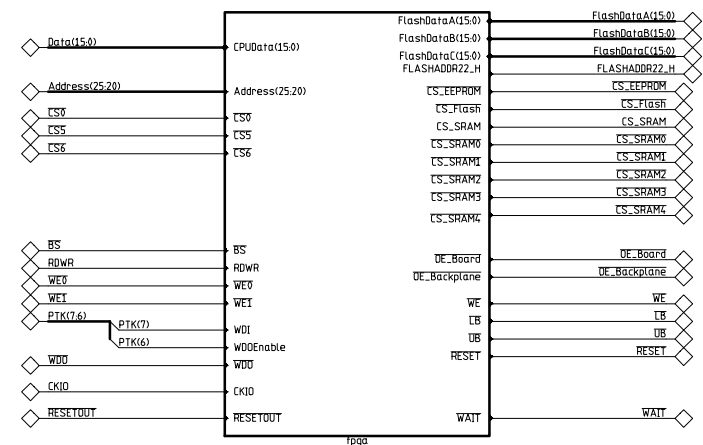
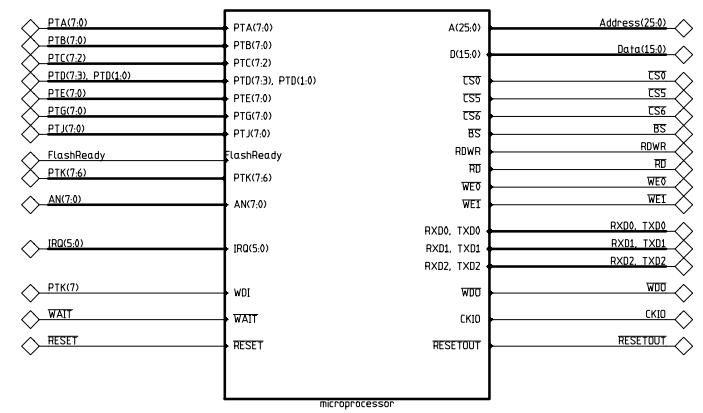

SPACE DYNAMICS LABORATORY
 UTAH STATE UNIVERSITY RESEARCH FOUNDATION
 North Logan, Utah 84341

TITLE			
USAT/ION-F CPU Flight Board Backplane Interface			
SCHEMATIC NAME	INSTANCE NAME	DRAWING NUMBER	REV
backplane_interfacesbk		30-0075	-
SCHEMATIC	INSTANCE	SCH-INST SHEET	
5 OF 6	1 OF 1	1 OF 1	



SPACE DYNAMICS LABORATORY
 UTAH STATE UNIVERSITY RESEARCH FOUNDATION
 North Logan, Utah 84341

TITLE			
USUSAT/ION-F CPU Flight Board Top-Level Diagram			
SCHEMATIC NAME	INSTANCE NAME	DRAWING NUMBER	REV
board_level.sbk		30-0075	-
SCHEMATIC	INSTANCE	SCH-INST SHEET	
6 OF 6	1 OF 1	1 OF 1	

D
C
B
A

D
C
B
A