

**Dr. Alan Brown and Timothy Mierzwicki**

## **Risk Metric for Multi-Objective Design of Naval Ships**

### **ABSTRACT**

The DoD Risk Management Guide requires risk assessment of acquisition performance, cost and schedule through the identification, subsequent analysis and prioritization of adverse program events based on their probability and consequences. This type of risk assessment is very important in concept exploration and design when considering new technologies, unique processes and novel concepts.

Uncertainty associated with the design process itself and the definition and selection of specific design alternatives can also have a significant impact on performance, cost and schedule risk. Inherent, statistical and modeling uncertainty, and uncertainty due to human error, must be considered in the design process, but uncertainty analysis requires a more detailed and computationally intensive probabilistic approach. It is most appropriate for post-exploration design optimization, after specific cost and performance goals and thresholds have been set, to maximize the probability of achieving these goals.

In this paper, a two-stage concept design strategy is proposed that uses a multi-objective optimization and simplified risk event approach for concept exploration, and a more rigorous multi-disciplinary optimization with uncertainty for concept development. Concept exploration identifies non-dominated design concepts and establishes the optimum relationship between effectiveness, cost and risk given a broad selection of technologies and design alternatives. In this context, non-dominated (N-D) refers to designs with the maximum effectiveness for a given cost and level of risk. This is a global optimization design problem that considers a wide range of performance, cost and risk possibilities. Risk is defined using a separate objective attribute, an Overall Measure of Risk (OMOR), which specifically addresses the high-risk events associated with the selection of new technologies, processes and concepts. With this perspective, decision-makers may establish rational requirements, select technologies, narrow the design space, and establish a non-dominated concept baseline design or set of designs.

Once these early decisions are made, concept development and the remaining design phases add detail, refine requirements and reduce risk. Optimization continues into concept development, but a single objective optimization based on uncertainty analysis is used, maximizing the probability of success (POS) of satisfying cost and effectiveness thresholds and other constraints established in concept exploration.

The methodology and a simple application of the multi-objective optimization and risk event approach are described in this paper.

### **MOTIVATION & INTRODUCTION**

Numerous transformational technologies such as composite materials, coatings, unmanned vehicles, automation, and integrated power systems are currently poised to shape the next generation of naval surface combatants. Engineers and program managers are traditionally pressured to: meet performance requirements; design and build within budget; and adhere to schedule. New programs and follow-on contracts have been won, lost, renewed, or canceled based on these three principles. However, a fourth dimension is rapidly gaining importance. New programs and follow-on contracts can now be lost or canceled because they are judged not innovative enough or not transformational enough. This consideration is driving designers to “innovate” much more than has been considered prudent since WWII.

Novel concepts and technologies carry with them an inherent risk of failure simply because their application is the first of its kind. Risks can be defined and quantified as the product of the probability of an occurrence of failure and a measure of the consequence of that failure. Since the objective of engineering is to design and build things to meet requirements, within budget, and on schedule, it is important to con-

sider risk, along with cost and performance, in trade assessments and technology selections made during concept exploration and development.

In today's ship acquisition process, design teams are built around the concept of Integrated Product and Process Development (IPPD). Naval ships are designed by Integrated Product Teams (IPTs) supported by Product Development Teams (PDTs) where risk and Total Ship System Engineering (TSSE) are buzzwords. On a typical IPT, risk is handled by a designated risk manager. The job of the risk manager is to maintain a risk register and track risks identified by Subject Matter Experts (SMEs) in each of the supporting PDTs. The PDTs are responsible for managing the risk of their product by mitigating the probability of adverse occurrence or failure, usually through tests, trials, and modeling and simulation. Although this practice is an effective method for identifying high risks and mitigating them to lower levels, it does not treat risk as an objective attribute of the design. Further, there is no metric by which to measure an overall level of risk.

The paper first presents the results of a literature and information search that investigates and describes risk and state of the art risk analysis techniques currently in practice. A simplified metric and methodology is developed to calculate, quantify, and compare relative overall risk for naval ship design optimization (Mierzwicki, 2003). To demonstrate this methodology, a naval ship risk register is developed for a notional ship design. A ship concept exploration case study is performed incorporating an Overall Measure of Risk (OMOR) function and risk items into a ship synthesis model capable of calculating cost, performance, and effectiveness. This case study uses a Multi-Objective Genetic Optimization (Brown and Salcedo, 2002; Salcedo, 1999; Brown and Thomas, 1998) to identify and define a series of non-dominated cost-effectiveness frontiers for a range of risk values.

## LITERATURE SURVEY

It is not unusual to associate the word "Risk" with the word "Engineering." In fact, Wang and Roush (2000) go as far as to define Engineering as "a profession of managing technical risk." So what is risk and how does it really relate to engineering?

Blanchard (1998) defines risk as "the potential that something will go wrong as a result of one or a series of events...measured as the combined effect of the probability of occurrence and the assessed consequence given that occurrence". Similar definitions are given by Modarres (1993) and Molak (1997). Historical perspectives on risk analysis applications in society are given by Covello and Mumpower (1985) and Molak (1997).

Wang and Roush characterize risk engineering as an integrated process, which includes two major parts: Risk Assessment (or Quantitative Risk Analysis) and Design for Risk Engineering. In Risk Assessment, uncertainties are modeled and assessed and their effects on a given decision are evaluated systematically. In Design for Risk Engineering, Risk associated with each decision alternative is identified and, if cost-effective, measures are taken to control or minimize possible consequences.

Risk analysis is a complex process, interdisciplinary in nature, and with many facets. As decision-makers, engineers tend to concern themselves more with quantitative methods than qualitative methods, and accordingly the literature and information search conducted for this paper was primarily focused towards understanding quantitative risk analysis (Mierzwicki, 2003). Most of the literature addresses safety and reliability analyses. Although useful for background and technique, the following were found to be most useful for assessing ship design risk:

- Modarres (1993) - quantitative definition of risk
- Blanchard (1998) - system engineering approach (SRAM)
- DoD Risk Management Guide (2000)
- Mavris (1998) - uncertainty approach

Modarres presents the "Risk Triplet" process:

1. Identify the failure event  $E_i$  or scenarios (sequence or chain of events).

2. Estimate the likelihood of these events,  $P_i$ .
3. Estimate the consequences of these events,  $C_i$ . Consequences may be measured on the basis of technical performance, cost, or schedule.

The results of this process are used to interpret the various contributors to risk, which are compared, ranked, and placed in perspective:

4. Calculate and graphically display  $P_i$  and  $C_i$ .
5. Calculate the expected risk value  $R$ :

$$R = \sum P_i \times C_i \quad (1)$$

Equation (1) assumes independence and small probabilities, i.e.  $\sum P_i \ll 1$ . Modarres includes two final steps in a risk analysis:

6. Identify cost-effective risk management alternatives.
7. Implement risk-management methods.

Blanchard describes a Risk Management Plan and how it fits into the Systems Engineering Management Plan (SEMP) where he defines Risk Management as “an organized method for identifying and measuring risk, and for selecting and developing options for handling risk”. Risk management includes Risk Analysis, Risk Assessment, and Risk Abatement. It addresses program, technology and design risks. Program areas of risk may include funding, schedule, contract relationships and political relationships. Technical risks relate primarily to the potential of not meeting a design requirement, not being able to produce an item in multiple quantities, and/or not being able to support a product in the field. Design engineering risks relate directly to technical performance measures (TPMs). For items classified as having “high” or “medium” risk, a risk abatement plan should be implemented. This constitutes a formal approach for eliminating (if possible), reducing, and/or controlling risk.

Many of the concepts found in Modarres and Blanchard are also found in DoD risk management. Currently, DoD policies and procedures that address risk management for acquisition programs are contained in the DoD 5000 series of directives. These directives describe the relationship between risk and various acquisition functions, establish reporting requirements, and address risk and cost analysis guidance as they apply to the Office of the Secretary of Defense.

The DoD Risk Management Guide (DSMC, 2001) prescribes risk assessment of technical performance, cost, and schedule through the identification and subsequent analysis (and prioritization) of prospective program events in terms of probability and consequences/impacts. Steps in this process include:

- Pre-risk activities: prepare a program risk management plan, identify team members, develop evaluation structures, and train IPTs.
- Risk identification activities: identify risk events, examine events for consequences, and document results of preliminary analysis. To identify risk events, program elements are broken down to a level where an evaluator can perform valid assessments, understand the significance of any risk and identify its causes. This is done using a work breakdown structure (WBS) for the program. The program’s risk events are compiled by examining each product and process element in the WBS to identify sources or areas of risk and possible consequences.
- Risk analysis activities: develop probability and consequence scales, determine levels/ratings, perform supporting analysis, document and prioritize results. Probability and consequence/impact assessments determine the probability of event occurrence and magnitude of the impact of an event, given the risk is realized. A variety of analyses and techniques may support this assessment e.g. comparisons with similar systems, relevant lessons learned, experience, test/prototype results, model/simulation data, expert judgment, document/plan analysis, sensitivity analysis, and analysis of alternatives.

- **Prioritization:** serves as the basis for risk-mitigation actions by ranking risk events. Risk ratings indicate the potential impact of risks on a program; they are often expressed as high, moderate, and low.

Another important risk approach applicable to ship design is uncertainty analysis. There are many definitions of uncertainty found in the literature. These definitions are very subject-matter specific. DeLaurentis and Mavris (2000) provide possibly the best definition for our application: “Uncertainty is the incompleteness in knowledge, either in information or context, which causes model-based predictions to differ from reality in a manner described by some probability distribution function.” Types of uncertainty may be categorized in various ways. Uncertainty categorized by source is described in Table 1. Each of these uncertainty types must be considered to maximize the probability of success (POS) or robustness of a ship design (Bandte, Mavris and DeLaurentis, 1999). This can be an extensive process including uncertainty identification, quantification, and integration in the modeling and analysis process. When uncertainties in consequence (performance, cost, and schedule) are calculated in a design uncertainty analysis, the resulting consequence probability distributions are a complete measure of risk.

**Table 1 - Types of Uncertainty**

<b>Types of Uncertainty</b>	<b>Description</b>
Inherent Uncertainty	Uncertainty due to the variability inherent in a system design, technology or the environment
Statistical Uncertainty	Uncertainty due to the incompleteness of statistical data
Modeling Uncertainty	Uncertainty resulting from the simplification of nature and physics
Human Uncertainty & Error	Uncertainty due to differences of opinion (or subjective uncertainty) and misdiagnosis (or diagnostic uncertainty) including: errors in calculation; selection of the wrong known data; inadequate design review; failure in calculating critical conditions; poor quality fabrication; use of the wrong materials; and abuse by operators.

## **APPROACHES TO RISK**

Based on the risk literature survey, two general approaches to risk as it applies to the problem of naval ship design optimization emerge:

1. **Risk Objective Attribute Approach** – Risk is quantified as a single objective attribute, an Overall Measure of Risk (OMOR), which represents the risk associated with discrete failure events in design performance, cost or schedule that depend on design variable values, selected technologies, systems and concepts. Risk is defined as the product of failure probability and failure consequence.
  - **Advantages**
    - Simple and direct integration into current multi-objective optimization approach.
    - Does not add significantly to computation time.
    - Transitions well into Risk Management Plan.
    - Consistent with DoD 5000 Risk Management approach.
  - **Disadvantages**
    - Identification and quantification of risk probability and consequence is based on expert opinion and judgment.
    - Metric is an index vice an actual probability, probability distribution, cost or performance measure.
    - Metric considers only significant risk event uncertainty. Other types of uncertainty are not considered explicitly.
2. **Uncertainty Approach** – Risk is quantified by developing probability distribution functions for objective attributes (cost, performance), and calculated by considering uncertainty (inherent, statistical, modeling, technology, human) explicitly in the ship synthesis (modeling and analysis) process.
  - **Advantages**

- Considers all types of uncertainty
- Consequences determined quantitatively by modeling and analysis vice expert opinion
- Design parameter pdfs more descriptive of uncertainty than simple estimate of failure probabilities
- Probability of success or failure is a more tangible risk metric than a risk index
- Disadvantages
  - Requires more setup time and effort for synthesis and optimization
  - Computationally intensive
  - Does not identify high risk events, technologies directly
  - Does not transition as directly into Risk Management Plan

It is concluded that uncertainty analysis is best applied in post-exploration design optimization, after specific cost and performance goals and thresholds have been set, to maximize the probability of achieving these goals.

This paper presents a rational approach for concept exploration that uses a multi-objective optimization to identify non-dominated design concepts and establish the optimum relationship between effectiveness, cost and risk given a broad selection of technologies and design alternatives. This is a global optimization design problem that considers a wide range of performance, cost and risk possibilities. In concept exploration, risk is defined using a separate objective attribute, an Overall Measure of Risk (OMOR), which specifically addresses high-risk events associated with the selection of new technologies, unique processes and novel concepts.

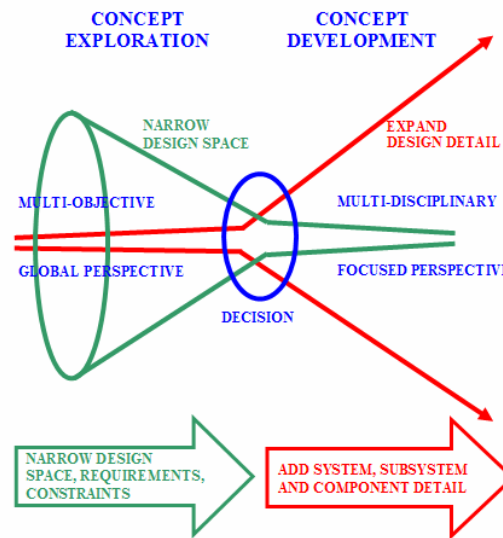

Figure 1 – Design Optimization Strategy

With this perspective, decision-makers may establish rational requirements, select technologies, narrow the design space, and establish a non-dominated concept baseline design or set of designs. Once these early decisions are made, the remaining design phases add detail, refine requirements and reduce risk. Optimization must continue into later design phases, but a single objective optimization based on uncertainty analysis may be used, maximizing the probability of success (POS) of satisfying cost and effectiveness thresholds and other constraints established in concept exploration. Higher fidelity analysis codes add more detail in later design stages when fully multi-disciplinary optimization studies are implemented. In later design stages, the design process focuses on an increasingly narrow region of the design space. This two-stage strategy to concept exploration and development is illustrated in Figure 1.

The remainder of this paper describes the Risk Objective Attribute (OMOR) Approach and its application in ship concept exploration and optimization. The application of uncertainty analysis in concept development will be presented in a future paper.

## EFFECTIVENESS OBJECTIVE ATTRIBUTE (OMOE)

A multi-objective ship design optimization requires quantitative objective-attribute metrics and functions for cost, effectiveness and risk. Effectiveness and risk are closely related and can be quantified in a similar manner using overall measures of effectiveness and risk developed as illustrated in Figure 2.

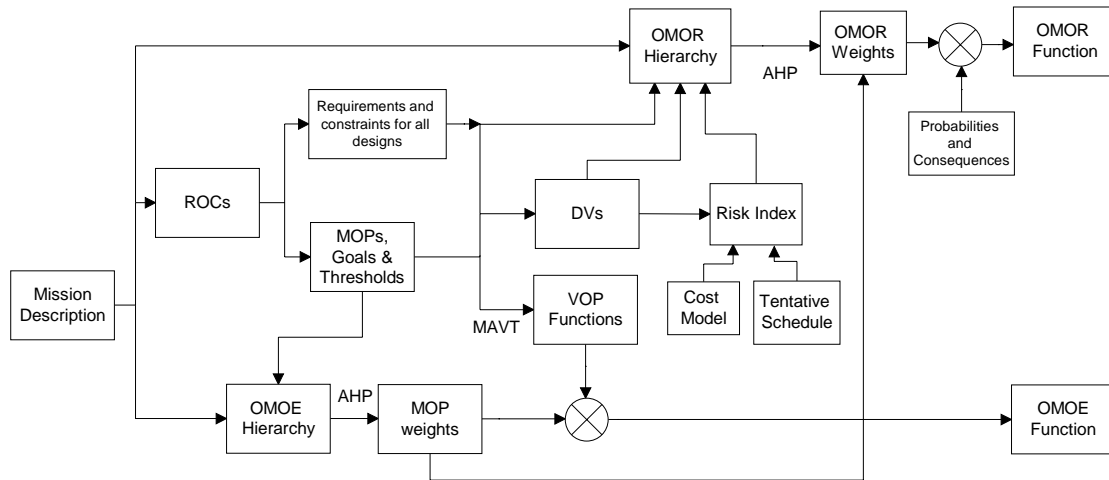

**Figure 2 - OMOE and OMOR Development Process**

Important terminology used in describing this process includes:

- Overall Measure of Effectiveness (OMOE) - Single overall figure of merit index (0-1.0) describing ship effectiveness over all assigned missions or mission types
- Overall Measure of Risk (OMOR) - Single overall figure of merit index (0-1.0) describing design performance, cost and schedule risk
- Mission or Mission Type Measures of Effectiveness (MOEs) - Figure of merit index (0-1.0) for specific mission scenarios or mission types
- Required Operational Capabilities (ROCs)
- Measures of Performance (MOPs) - Specific ship or system performance metric independent of mission (speed, range, number of missiles)
- Value of Performance (VOP) - Figure of merit index (0-1.0) specifying the value of a specific MOP to a specific mission area for a specific mission type.
- Design Variables (DVs) – Ship physical characteristics controlled by the designer; used to define a ship design at an level of detail appropriate for a particular design stage

There are a number of inputs which must be integrated when determining overall mission effectiveness in a naval ship: 1) defense policy and goals; 2) threat; 3) existing force structure; 4) mission need; 5) mission scenarios; 6) modeling and simulation or war gaming results; and 7) expert opinion. Ideally, all knowledge about the problem could be included in a master war-gaming model to predict resulting measures of effectiveness for a matrix of ship performance inputs in a series of probabilistic scenarios. Regression analysis could be applied to the results to define a mathematical relationship between input ship MOPs and output effectiveness. The accuracy of such a simulation depends on modeling the detailed interactions of a complex human and physical system and its response to a broad range of quantitative and qualitative variables and conditions including ship MOPs. Many of the inputs and responses are probabilistic so a statistically significant number of full simulations must be made for each set of discrete input variables. This extensive modeling capability does not yet exist for practical applications.

An alternative to modeling and simulation is to use expert opinion directly to integrate these diverse inputs, and assess the value or utility of ship MOPs in an OMOE function. This can be structured as a multi-attribute decision problem. Two methods for structuring these problems dominate the literature: Multi-Attribute Utility Theory (Keeney and Raiffa 1976) and the Analytical Hierarchy Process (Saaty, 1996). In the past, supporters of these theories have been critical of each other, but recently there have

been efforts to identify similarities and blend the best of both for application in Multi-Attribute Value (MAV) functions (Belton, 1986). This approach is adapted here for deriving an OMOE and OMOR.

The process described in Figure 2 begins with the Mission Need Statement and mission description. Required capabilities (ROCs) are identified to perform the ship's mission(s) and measures of performance (MOPs) are specified for those capabilities that will vary in the designs as a function of the ship design variables (DVs). Each MOP is assigned a threshold and goal value. Capability requirements and constraints applicable to all designs are also specified. An Overall Measure of Effectiveness (OMOE) hierarchy is developed for the MOPs using the Analytical Hierarchy Process (AHP) to calculate MOP weights and Multi-Attribute Value Theory (MAVT) to develop individual MOP value functions. The result is a weighted overall effectiveness function (OMOE) that is used as one of three objectives in the multi-objective optimization. In the AHP, pair-wise comparison questionnaires are produced to solicit expert and customer opinion, required to calculate AHP weights. Value of Performance (VOP) functions (generally S-curves) are developed for each MOP and VOP values are calculated using these functions in the ship synthesis model. A particular VOP has a value of zero corresponding to the MOP threshold, and a value of 1.0 corresponding to the MOP goal. Separate hierarchies are developed for each mission or condition. MOP weights and value functions are finally assembled in a single OMOE function:

$$OMOE = \sum_i w_i VOP_i(MOP_i) \quad (2)$$

where  $w_i$  represents individual MOP weights and  $VOP_i(MOP_i)$  are the VOP functions.

## **RISK OBJECTIVE ATTRIBUTE (OMOR)**

The risk assessment and quantification methodology required to build an OMOR is summarized in the following steps:

1. Understand technology alternatives, ship requirements, schedules and cost estimates. Set effectiveness and performance metrics, goals and thresholds.
2. Select ship design variables (DVs) and process variables (PVs).
3. Identify potential risk areas and events associated with each design and process variable option. Build a risk register (spreadsheet).
4. Assign probabilities ( $P_i$ ) and consequences ( $C_i$ ) for each risk event ( $E_i$ ).
5. Calculate a risk rating ( $R_i$ ) for each risk event.
6. Define the overall measure of risk (OMOR) function, Equation (3).
7. Perform ship synthesis and optimization.

After the ship's missions and required capabilities are defined and technology options identified, these options and other design variables are assessed for their potential contribution to overall risk. MOP weights, tentative ship and technology development schedules and cost predictions are also considered.

Table 2 (DSMC, 2001) provides a list of specific areas or sources of risk that should be considered to identify significant risks associated with each design or process variable option. This is not an exhaustive list, but provides an excellent beginning. If a WBS has been developed, risks may be determined by first examining WBS element products and processes in terms of risk areas, then allocating the risks to DP and PV options. Once risk events have been identified, each risk event is listed in a Risk Register, grouped by DV/PV and their options. DVs/PVs are also grouped by risk categories to assist later tracking, mitigation and management. Risk categories are based on the Level 3 (single digit) elements in the work breakdown structure for ship systems. Each row in the Risk Register corresponds to a separate risk associated with each DP option.

**Table 2 - Significant Risks by Critical Risk Areas**

Risk Area	Significant Risks
<b>Threat</b>	<ul style="list-style-type: none"> <li>• Uncertainty in threat accuracy.</li> <li>• Sensitivity of design and technology to threat.</li> <li>• Vulnerability of system to threat and threat countermeasures.</li> <li>• Vulnerability of program to intelligence penetration.</li> </ul>
<b>Requirements</b>	<ul style="list-style-type: none"> <li>• Operational requirements not properly established or vaguely stated.</li> <li>• Requirements are not stable.</li> </ul>
<b>Design</b>	<ul style="list-style-type: none"> <li>• Status of system development.</li> <li>• Requirement for increased skills.</li> <li>• Reliance on immature technology or “exotic” materials to achieve performance.</li> <li>• Status of software design, coding, and testing.</li> </ul>
<b>Test &amp; Evaluation</b>	<ul style="list-style-type: none"> <li>• Test planning not initiated early in program (Phase 0).</li> <li>• Testing does not address the ultimate operating environment.</li> <li>• Test procedures do not address all major performance and suitability specifications.</li> <li>• Test facilities not available to accomplish specific tests, especially system-level tests.</li> <li>• Insufficient time to test thoroughly.</li> </ul>
<b>Simulation</b>	<ul style="list-style-type: none"> <li>• M&amp;S are not verified, validated, or accredited for the intended purpose.</li> <li>• Program lacks proper tools and modeling and simulation capability to assess alternatives.</li> </ul>
<b>Technology</b>	<ul style="list-style-type: none"> <li>• Success depends on unproved technology for success.</li> <li>• Success depends on achieving advances in state-of-the-art technology.</li> <li>• Technology has not been demonstrated in required operating environment.</li> <li>• Technology relies on complex hardware, software, or integration design.</li> </ul>
<b>Logistics</b>	<ul style="list-style-type: none"> <li>• Inadequate supportability late in development or after fielding, resulting in need for engineering changes, increased costs, and/or schedule delays.</li> <li>• Life-cycle costs not accurate because of poor logistics supportability analyses.</li> </ul>
<b>Production/ Facilities</b>	<ul style="list-style-type: none"> <li>• Production not sufficiently considered during design.</li> <li>• Inadequate planning for long lead items and vendor support.</li> <li>• Production processes not proven.</li> <li>• Prime contractors do not have adequate plans for managing subcontractors.</li> <li>• Sufficient facilities are not readily available for cost-effective production.</li> <li>• Contract offers no incentive to modernize facilities or reduce cost.</li> </ul>
<b>Concurrency</b>	<ul style="list-style-type: none"> <li>• Immature or unproven technologies will not be adequately developed before production.</li> <li>• Concurrency established without clear understanding of risks.</li> </ul>
<b>Capability of Developer</b>	<ul style="list-style-type: none"> <li>• Developer has limited experience in specific type of development.</li> <li>• Contractor has poor track record relative to costs and schedule.</li> <li>• Contractor has experienced loss of key personnel.</li> <li>• Prime contractor relies excessively on subcontractors for major development efforts.</li> <li>• Contractor requires significant capitalization to meet program requirements.</li> </ul>
<b>Technology Cost/Funding</b>	<ul style="list-style-type: none"> <li>• Realistic cost objectives not established early.</li> <li>• Excessive life-cycle costs due to inadequate treatment of support requirements.</li> <li>• Funding profile is not stable from budget cycle to budget cycle.</li> </ul>
<b>Schedule</b>	<ul style="list-style-type: none"> <li>• Schedule does not reflect realistic acquisition planning.</li> <li>• Resources are not available to meet schedule.</li> </ul>
<b>Technology Management</b>	<ul style="list-style-type: none"> <li>• Proper mix (experience, skills) of people not assigned to PMO or to contractor team.</li> <li>• Effective risk assessments not performed or results not understood and acted on.</li> </ul>

**Table 3 - Probability/Likelihood Level Criteria, P<sub>i</sub>**

Likelihood Level	Description
0.1	Remote
0.3	Unlikely
0.5	Likely
0.7	Highly likely
0.9	Near Certain

Once risk events corresponding to DV and PV options have been analyzed and entered into the risk register, the likelihood of each event (P<sub>i</sub>) and the consequence of each event (C<sub>i</sub>) must be estimated. These estimates are made by one or more experts who are familiar with each risk source/area and DV/PV option. In concept exploration, there is rarely sufficient data or knowledge to make a precise quantitative assessment of risk probabilities and consequences. Simple descriptive criteria are used to establish quantitative levels of likelihood and consequences. The criteria are based on similar approaches by Blanchard (1998) and DoD. For each risk event, the likelihood of the event is estimated using Table 3. There are five levels of likelihood (0.1-0.9) with corresponding subjective criteria of Remote, Unlikely, Likely, Highly Likely, and Near Certainty. Consequence is estimated for each risk



event using Table 4. There are also five levels of likelihood with different subjective criteria for each type of risk: performance, schedule and cost.

**Table 4 – Consequence Level Criteria**

Level	Given the Risk is Realized, What Is the Magnitude of the Impact?		
	Performance, $C_i$	Schedule, $C_k$	Cost, $C_j$
0.1	Minimal or no impact on specific MOP	Minimal or no impact on total ship design or production schedule	Minimal or no impact on total objective cost
0.3	Acceptable with some reduction in margin	Additional resources required; able to meet need dates	<5% increase
0.5	Acceptable with significant reduction in margin	Minor slip in key milestones; not able to meet need date	5-7% increase
0.7	Acceptable; no remaining margin	Major slip in key milestone or critical path impacted	7-10% increase
0.9	Unacceptable	Can't achieve key team or major program milestone	>10% increase

To define an OMOR function, a simple risk hierarchy, the Analytical Hierarchy Process (AHP), and expert pairwise comparison are used to calculate OMOR hierarchy weights,  $W_{perf}$ ,  $W_{cost}$ ,  $W_{sched}$ . The OMOE performance weights,  $w_i$ , calculated previously that are associated with risk events and specific MOPs are normalized to a total of 1.0, and reused to calculate the OMOR. These weights already reflect relative MOP value. Finally, the OMOR is calculated using Equation (3).

$$OMOR = W_{perf} \sum_i \frac{w_i}{\sum_i w_i} P_i C_i + W_{cost} \sum_j P_j C_j + W_{sched} \sum_k P_k C_k \quad (3)$$

## MULTI-OBJECTIVE GENETIC OPTIMIZATION (MOGO)

Mission effectiveness, cost and risk have different metrics and cannot logically be combined into a single objective attribute. Multiple objectives associated with a range of designs must be presented separately, but simultaneously, in a manageable format for trade-off and decision-making. There is no reason to pay or risk more for the same effectiveness or accept less effectiveness for the same cost or risk. Various combinations of ship features and dimensions yield designs of different effectiveness, cost and risk. A non-dominated frontier represents the best effectiveness that can be achieved for a given cost and risk. Each point on the frontier represents a candidate ship design. Preferred designs must always be on the non-dominated frontier. The selection of a particular non-dominated design depends on the decision-maker's preference for cost, effectiveness and risk. This preference may be affected by the shape of the frontier and cannot be rationally determined a priori.

A Multi-Objective Genetic Optimization (MOGO) is used in concept exploration to search the design space and identify non-dominated designs (Brown and Salcedo, 2002; Salcedo, 1999; Brown and Thomas, 1998). A flow chart for the MOGO is shown in Figure 3. The MOGO generates, assesses and improves a population of designs in sequential generations. In the first design generation, the optimizer randomly defines a population of ships using the ship synthesis model to balance each ship and to calculate cost, effectiveness and risk. Each of these designs is ranked based on their fitness or dominance in effectiveness, cost and risk relative to the other designs in the population. Penalties are applied for infeasibility and niching or bunching-up in the design space. The second generation of the optimization is randomly selected from the first generation, with higher probabilities of selection assigned to designs with higher fitness. Twenty-five percent of these are selected for crossover or swapping of some of their design variable values. A very small percentage of randomly selected design variable values are mutated or replaced with a new random value. As each generation of ships is selected, the ships spread across and define the effectiveness/cost/risk design space and frontier.

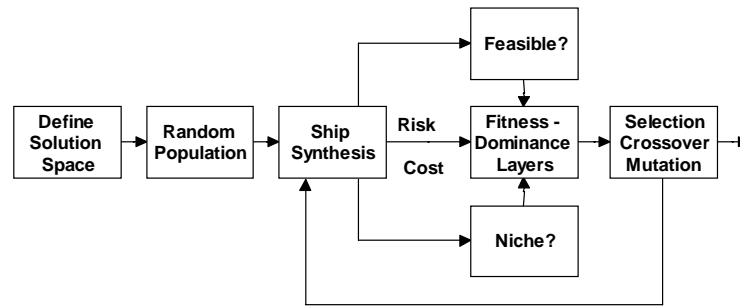

Figure 3 - Multi-Objective Genetic Optimization

## DESIGN CASE STUDY

A simple design case study was performed to demonstrate the Risk Objective Attribute (OMOR) Approach and its application in ship concept exploration and optimization. The case study is based on a Mission Need Statement for an unmanned combat air vehicle (UCAV) carrier (CUVX), Figure 4. CUVX is required to operate in littoral areas, close-in, depend on stealth, with high endurance and low manning, and support UCAV's, UAV's and LAMPS, providing for takeoff and landing, fueling, maintenance, weapons load-out, planning and control. The design must minimize life cycle cost through the application of producibility enhancements and manning reduction. The design must minimize personnel vulnerability in combat through automation and reduced manning.

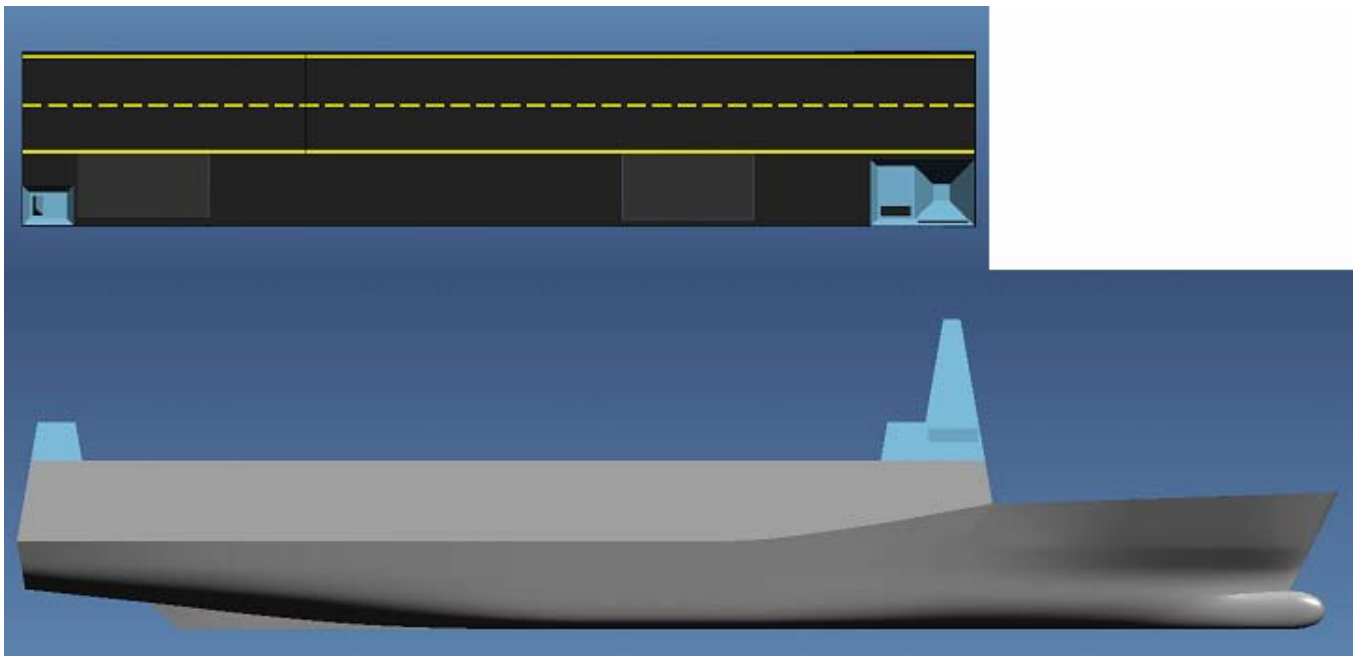
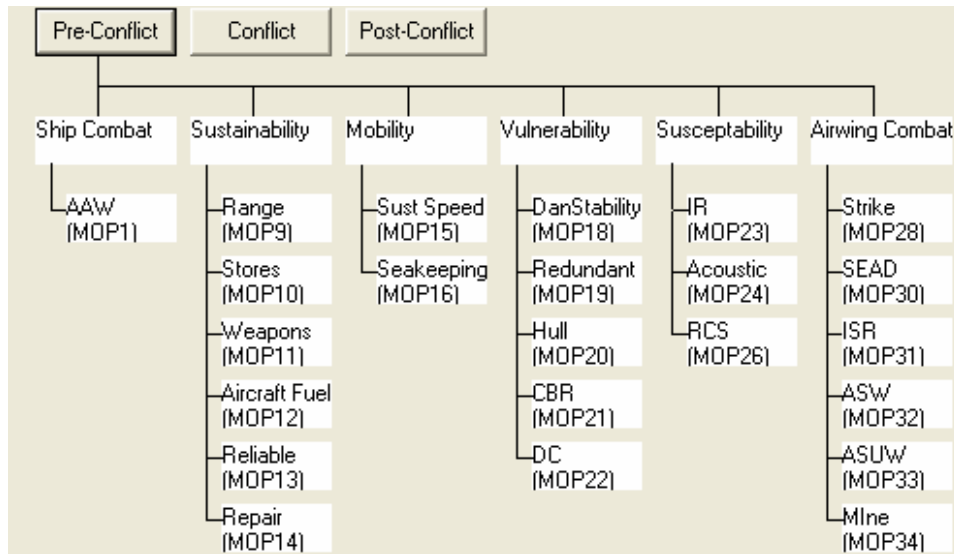

Figure 4. Plan View of Recovery Deck and Profile View of CUVX HI2

Detailed Concept of Operations, Projected Operational Environment, Mission Scenarios and Required Operational Capabilities were developed for CUVX. Technologies were investigated consistent with these required capabilities including: wave-piercing tumblehome (WPTH) hull form, electromagnetic aircraft launching system (EMALS), advanced arresting gear (AAG), electromagnetic aircraft recovery system (EARS), integrated power system (IPS), peripheral vertical launch system (PVLS), aviation and ship automation, advanced double hull (ADH), and because of the necessary smaller (than a CVX) size of this ship, a separate and semi-enclosed launch deck located below the recovery deck. Design variables spanned the full scope of necessary trade studies and ship sizing, Table 5. MOPs were specified for required capabilities. Each MOP was assigned a threshold and goal value. An Overall Measure of Effectiveness (OMOE) hierarchy was developed for the MOPs, Figure 5, and an OMOE function was developed using AHP and MAVT.

**Table 5. CUVX Design Variables**

	Description	Metric	Range	Increments
1	Hull form	type	General monohull, LPD-17, WPTH	3
2	Prismatic coefficient	Non-dimensional	.6-.8	20
3	Max section coefficient	Non-dimensional	.9-.99	9
4	Displacement to length ratio	lton/ft2	50-90	20
5	Beam to Draft Ratio	Non-dimensional	3-5	20
6	Length to Depth Ratio	Non-dimensional	6-8	20
8	Aircraft launch deck?	y/n	0,1	2
9	Deckhouse volume ratio	Non-dimensional	.05-.3	25
10	AAW system	alternative	1,2	2
11	LAMPS helos	#	2,4	2
18	Endurance range	nm	4000,8000,12000	3
19	Stores duration	days	60,90,120	3
20	Propulsion system	alternative	1-14	14
21	Ship manning and automation factor	Non-dimensional	.5-1.0	5
22	Hull structure type	type	Conventional, ADH	2
23	Collective Protection Sys	extent	None, partial, full	3
24	UAVs	#	5-20	15
25	UCAVs	#	10-30	20
26	Aviation manning and automation factor	Non-dimensional	.5-1.0	5
27	Ship aircraft fuel	MT/UCAV	30.-60.	10
28	Ship aircraft weapons	MT/UCAV	5.-15.	10

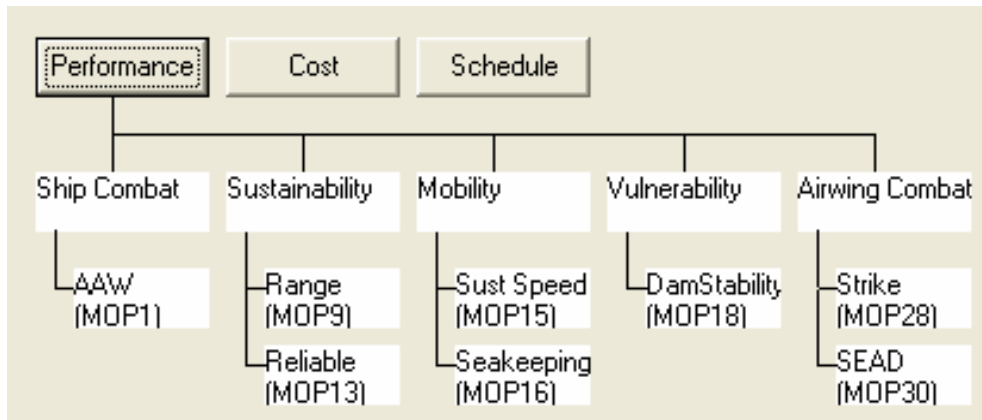

**Figure 5. CUVX OMOE Hierarchy**

An Overall Measure of Risk (OMOR) function was developed using the Risk Objective Attribute Approach described above. Risk areas and events associated with the new technologies were identified and included in a Risk Register, Table 6. This register identifies potential cost, performance, and schedule risk events. Risk events are directly related to the design variables (DVs). Risk Factors ( $R_i$ ) are calculated for each risk event. Each  $R_i$  is the product of a Probability of Failure ( $P_i$ ) and a Consequence of Failure ( $C_i$ ) which are estimated using the methodology described in the previous section. MOPs that are related to risk events are organized in separate OMOR hierarchy, Figure 6. The same MOP weighting factors developed previously for the OMOE calculation are used for performance risk with their total normalized to 1.0. These results are incorporated into the OMOR function for CUVX, Equation (3).

**Table 6. CUVX Risk Register**

SWBS	Risk Type	DP Description	DP Value	Risk Event E <sub>i</sub>	Risk Description	P <sub>i</sub>	C <sub>i</sub>	R <sub>i</sub>
Armament	Performance	Peripheral VLS	1	Failure of PVLS EDM test	Will require use of VLS or RAM with impact on flight deck and hangar deck area and ops	0.3	0.5	0.15
Hull	Performance	WPTH hull form	2	Unable to accurately predict endurance resistance	Will over-predict endurance range.	0.2	0.3	0.06
Propulsion	Performance	Integrated power system	>5	Development and use of new IPS system	New equipment and systems will have reduced reliability	0.4	0.4	0.16
Hull	Performance	WPTH hull form	2	Unable to accurately predict sustained speed resistance	Will over-predict sustained speed.	0.2	0.5	0.1
Hull	Performance	WPTH hull form	2	Unable to accurately predict WPTH seakeeping performance	Seakeeping performance will not be acceptable	0.5	0.5	0.25
Hull	Performance	WPTH hull form	2	Unable to accurately predict WPTH extreme motions and stability	Damaged stability performance will not be acceptable	0.7	0.7	0.49
Hull	Performance	Separate launch deck	1	Concept doesn't work preventing simultaneous launch and recovery for SEAD mission	Unforeseen problems with dedicated launch deck (launch, fuel, weapons)	0.4	0.8	0.32
Hull	Performance	Separate launch deck	1	Concept doesn't work preventing simultaneous launch and recovery for Strike mission	Unforeseen problems with dedicated launch deck (launch, fuel, weapons)	0.4	0.9	0.36
Propulsion	Schedule	Integrated power system	>5	Development and integration of new IPS system will be behind schedule	Unexpected problems with new equipment and systems	0.3	0.3	0.09
Propulsion	Cost	Integrated power system	>5	Development and integration of new IPS system will have cost overruns	Unexpected problems with new equipment and systems	0.3	0.6	0.18
Auxiliary	Schedule	EMALS	>5	Development and integration of new EMALS system will be behind schedule	Unexpected problems with new equipment and systems and integration with IPS pulse power	0.5	0.4	0.20
Auxiliary	Cost	EMALS	>5	Development and integration of new EMALS system will have cost overruns	Unexpected problems with new equipment and systems and integration with IPS pulse power	0.5	0.6	0.3
Armament	Cost	Peripheral VLS	1	PVLS EDM test and development system will have cost overruns	Unexpected problems with new equipment and systems	0.2	0.4	0.08
Armament	Schedule	Peripheral VLS	1	PVLS EDM test and development will be behind schedule	Unexpected problems with new equipment and systems	0.2	0.2	0.04
Hull	Schedule	WPTH hull form	2	Delays and problems with WPTH testing	Unexpected problems or unsatisfactory performance of new hull form	0.5	0.7	0.35
Hull	Cost	WPTH hull form	2	Delays and problems with WPTH testing	Unexpected problems or unsatisfactory performance of new hull form	0.5	0.6	0.3



**Figure 6 - CUVX Performance Risk Hierarchy**

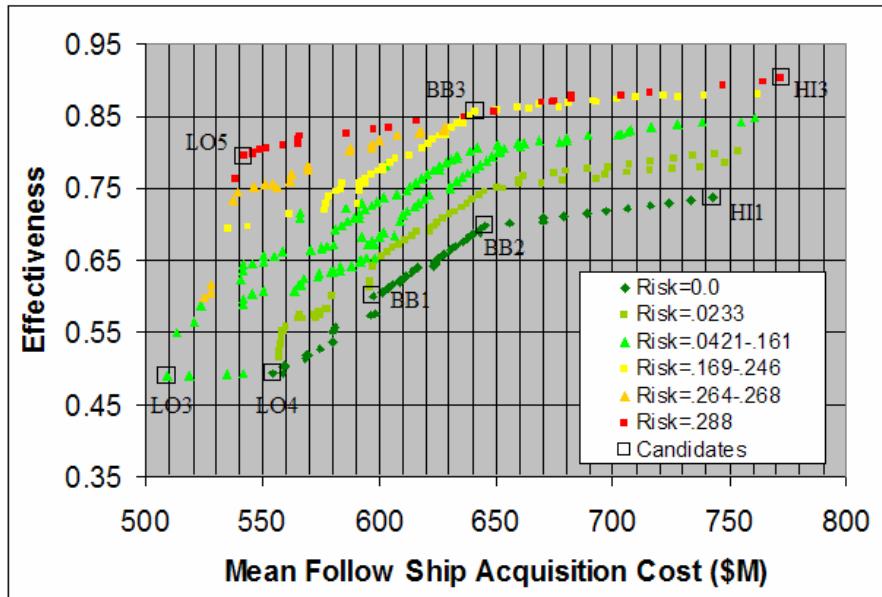

Figure 7 – CUVX Non-Dominated Frontiers

Table 7 – CUVX Non-Dominated Design Candidates

	<b>LO4</b>	<b>BB2</b>	<b>HI3</b>
Cost Follow (\$M)	555	645	772
Cost Lead (\$M)	840	751	1192
OMOR	0.0000	0.0000	0.2877
OMOE	0.4931	0.6977	0.9021
Hullform	Monohull	LPD mod-repeat	WPTH
Δ (lton)	22496	25873	28996
LWL (ft)	630	656	696
Beam (ft)	82	97	94
Draft (ft)	22	23	23
D10 (ft)	83	87	97
Cp	0.720	0.647	0.710
Cx	0.950	0.941	0.950
Launch Deck	no	no	yes
Range (nm)	12000	8000	4000
Duration (days)	120	120	120
Collective Protection System	full	full	full
Propulsion System	2 x LM2500, 1 shaft, mechanical drive	4 x PC2.5V16, 2 shafts, mechanical drive	5 x PC2.5V16, 2 shafts, IPS
AAW	2	2	1
Advanced Double Hull	no	no	yes
# of Helos	4	4	4
# of UAVs	18	20	18
# of UCAVs	10	28	28
Ship Aircraft Fuel (MT)	570	1680	1680
Ship Aircraft Weapons (MT)	50	140	392
Sustained Speed (knots)	22.6	21.3	20.2
Manning	490	863	901

A MOGO was performed for CUVX using the CUVX OMOE, OMOR, and mean follow-ship acquisition cost as objective attributes. Results are displayed in Figure 7. Each point in Figure 7 represents objective attribute values for a feasible non-dominated ship design. Non-dominated frontiers for different levels of risk (OMORs) are represented by different colors. Alternative designs at the extremes of the frontiers (HI and LO) and at knees in the curve (BB1, 2 and 3) are often the most interesting possibilities for the customer. For this case study, the most illustrative comparisons are between the high-end ship, HI3, the low risk ship, LO4, and a knee-in-the-curve ship, BB2. Descriptions of these ships are provided in Table 7

Non-dominated ships include all three hullform types. The LPD modified-repeat hullform offers cost advantages and dominates the center region of the design space, but since the modified-repeat requires a specific displacement (25000 MT +/- 2%), low end ships with displacements less than 25000 MT and high-end ships with displacements greater than 25000 MT must be either general monohulls or WPTH. Low-end (cost) variants have one shaft, high-end variants have two shafts. The rising slopes seen in each frontier between acquisition costs of \$550M and \$650M represent an increase in the number of UCAVs and UAVs with their necessary support and manning. The higher risk frontiers represent a greater use of higher risk alternatives: WPTH, peripheral vertical launch, separate launch deck, IPS and EMALS. HI3 has all of these alternatives, LO4 and BB2 have none. HI3 is the largest ship with the most aircraft and crew. It has the lowest signatures, advanced double hull, and high-end combat system. It has the lowest endurance because it is weight-constrained (29000 MT). Adding weight for aircraft and survivability provides a greater increase in effectiveness than adding fuel weight, but it costs more. BB2 has the lowest lead-ship cost because it is a modified-repeat LPD.

If a \$650M follow-ship acquisition cost is acceptable to the customer, BB2 and BB3 are very cost effective alternatives depending on the customer's preference for risk to achieve effectiveness. If the customer must have effectiveness greater than  $OMO E = 0.75$ , then they must accept some risk.

The display of alternatives in Figure 7 allows the customer to consider these trade-offs with the assurance that all non-dominated designs provide the most effectiveness for a given cost and level of risk. Once a baseline design is selected, rational requirements and thresholds can be set. Without this perspective on the relationship between cost, risk and effectiveness, requirements may be arbitrary, inconsistent and not optimal. When this condition exists, it creates major inefficiencies in the design and acquisition process with added and unnecessary cost and risk.

## CONCLUSIONS

This paper proposes a two-stage concept design strategy that uses a multi-objective optimization and simplified risk event approach for concept exploration and requirements definition, and a more rigorous multi-disciplinary optimization with uncertainty for concept development. Concept exploration identifies non-dominated design concepts and establishes the optimum relationship between effectiveness, cost and risk given a broad selection of technologies and design alternatives.

In concept exploration, risk is defined using a separate objective attribute, an Overall Measure of Risk (OMOR), which specifically addresses the high-risk events associated with the selection of new technologies, processes and concepts. The advantages of this approach for concept exploration are: simple and direct integration into current multi-objective optimization approach; does not add significantly to computation time; transitions well into a Risk Management Plan; consistent with the DoD 5000 Risk Management approach.

A simple case study is used to demonstrate that without the perspective that this methodology provides, requirements and baseline design(s) may be arbitrary, inconsistent and not optimal. This can create major inefficiencies later in the design and acquisition process with added and unnecessary cost and risk, and a final design that is not cost-risk effective.

Ongoing and future work continues to refine this process with transition into a multi-disciplinary optimization with uncertainty in concept development.

## REFERENCES

- Bandte, O., Mavris, D.N., DeLaurentis, D.A., "Viable Designs Through a Joint Probabilistic Estimation Technique", SAE 1999-01-5623, 1999.
- Belton, V. (1986), "A comparison of the analytic hierarchy process and a simple multi-attribute value function", European Journal of Operational Research.
- Blanchard, B.S. (1998), *System Engineering Management*, John Wiley & Sons, New York.
- Brown, A.J., Thomas, M. (1998), "Reengineering the Naval Ship Concept Design Process", From Research to Reality in Ship Systems Engineering Symposium, ASNE.
- Brown, A.J. and Salcedo, J. (2002), "Multiple-Objective Optimization in Naval Ship Design", ASNE Day 2002.
- Covello VT and Mumpower J. (1985), "Risk Analysis and Risk Management: A Historical Perspective", Risk Analysis 5(2): 103-120.
- Defense Systems Management College (2001), *Risk Management Guide for DOD Acquisition*, 4<sup>th</sup> Edition, Defense Acquisition University Press, Fort Belvoir, VA.
- DeLaurentis, D.A. and Mavris, D.N., "Uncertainty Modeling and Management in Multidisciplinary Analysis and Synthesis", AIAA-2000-0422, 2000.
- Keeney, R.L. and Raiffa, H. (1976), *Decisions with Multiple Objectives: Preferences and Value Tradeoffs*, John Wiley and Sons, New York.
- Mavris, D.N., DeLaurentis, D.A., Bandte, O., and Hale, M.A. (1998), "A Stochastic Approach to Multidisciplinary Aircraft Analysis and Design", 36<sup>th</sup> Aerospace Sciences Meeting & Exhibit, Reno, NV.
- Mierzwicki, T. (2003), "Risk Index for Multi-objective Design Optimization of Naval Ships", MS Thesis, Department of Aerospace and Ocean Engineering, Virginia Tech.
- Molak, V. (1997), *Fundamentals of Risk Analysis and Risk Management*. CRC Press, Lewis Publishers, Boca Raton.
- Saaty, T.L. (1996), *The Analytic Hierarchy Process*, RWS Publications, Pittsburgh.
- Salcedo, Juan (1999), "Selecting Optimum Parameter Values For Pareto-Genetic Optimization Of Complex Systems", Master of Science Thesis, Virginia Tech, December.
- Shahak, Shmuel (1998), "*Naval Ship Concept Design: an Evolutionary Approach*", Master's thesis, Department of Ocean Engineering, Massachusetts Institute of Technology.
- Wang, J.X. and M.L. Roush (2000), *What Every Engineer Should Know About Risk Engineering and Management*, Marcel Dekker, New York.

**Contact:**

Dr. Alan Brown  
NAVSEA Professor of Ship Design  
CAPT USN(ret)

Department of Aerospace and Ocean Engineering  
215 Randolph Hall  
Virginia Polytechnic Institute and State University  
Blacksburg, VA 24061

(540) 231-4950  
Fax (540) 231-9632  
email brown@aoe.vt.edu

<http://www.aoe.vt.edu/>

**Dr. Alan Brown, Capt USN (ret)** is currently Professor, Department of Aeronautics and Ocean Engineering, Virginia Tech. He was Professor of Naval Architecture, and directed the Naval Construction and Engineering Program at MIT from 1993 to 1997. As an Engineering Duty Officer he served in ships, fleet staffs, shipyards, NAVSEA and OPNAV. While at MIT and since retirement he has served as technical advisor to US delegations at the International Maritime Organization (IMO) in tanker design, oil outflow, intact stability, damaged stability and tanker risk. He is chairman of the SNAME Ad Hoc Panel on Structural Design and Response in Collision and Grounding, a member of the SNAME Ship Design Committee and SNAME Panel O-44, Marine Safety and Pollution Prevention. He is a past Northeast Regional Vice President of SNAME, a past member of the ASNE Council and Past Chairman of the New England Section of SNAME. He received a PhD in Marine Engineering from MIT in 1986.

**Timothy Mierzwicki** works for Northrop Grumman Ship Systems (NGSS) as a Naval Architect and Systems Engineer. He completed his graduate studies as a Virginia Tech distance-learning student, first from Northrop Grumman's Ingalls shipyard in Pascagoula, MS then later from the NGSS Washington D.C. office after accepting a transfer in November 2002. He was a naval architect on the DD21 Gold Team responsible for design, calculations, analysis, and tests leading to the development of DD21 and DD(X) technical proposal baselines. He has worked with both the Hull Technical and Noise Shock and Vibrations scientific groups at Northrop Grumman's Ingalls Shipyard supporting production evolutions and at sea tests on DDG and LHD class ships. He has provided in yard and at sea engineering support for airborne noise tests, translations, launches, surveys, and inclining experiments on DDG and LHD vessels. He continues to work on developing corporate wide SE processes and procedures, and has worked on various proposals and ship development efforts at NGSS. He was the lead NGSS engineer to BIW and Dassault Systems leading to the custom development of a CATIA shipbuilding software package supporting Conceptual Ship Design & Arrangement, and Structural Design & Analysis.